

STERN LATCH

Sterngold offers the world's most respected intracoronal attachments for non-resilient partial denture and bridgework applications.

The Stern Latch intracoronal attachments are precision manufactured to .0001" tolerances. This accuracy permits interchangeability of parts.



Indications

- Partial dentures - non-resilient bilateral or unilateral, bounded or free-end.
- Cross-arch stabilization of non-resilient unilateral partial dentures.
- Segmented fixed bridgework.

Contraindications

- Removable partial denture patients requiring a resilient connection to the abutment teeth.
- Inadequate arch space for placement of the attachment.
- Insufficient patient dexterity for insertion and removal of a precision prosthesis.

Summary

- Intracoronal precision slide attachment.
- Adjustable gingival latch.
- Gold alloy (Ceramicor) male.
- Iridium-platinum female.

Fixation: Male - soldered or laser welded to removable partial denture framework, or cast to with gold alloys
 Female - soldered, or cast to with precious and non-precious alloys.

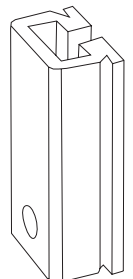
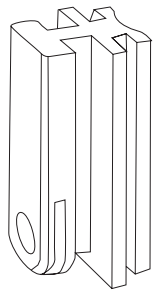
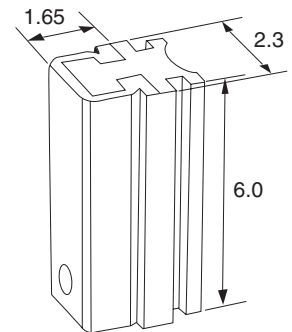

Minimum Space Required:

Height*	FC width	Prep depth	RC width
3.5mm	3.3mm	2.2mm	3.3mm





*Using a lingual stabilizing arm is always a good idea with rigid attachments, but is necessary when the attachment is reduced to 4.0mm or less.

Unlike most attachments, the Stern Latch does not rely only on friction between the male and female for retention. It also features a gingival latch on the male that clicks over a ridge in the female and then becomes passive. After insertion the latch acts only to resist a deplating force.

Because it is latch retained, rather than only friction retained, the Stern Latch maintains its retention better; and, therefore, requires fewer adjustments. It can be reduced to as small as 3.5mm high for close bites with little loss of retention. Although it is a good idea, the Stern Latch, does not require a lingual stabilizing arm to be added to the partial denture framework when it is long. But all intracoronal attachments should have a stabilizing arm added to the design when they are reduced to approximately 4mm or less.

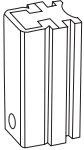
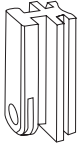

ATTACHMENT DESCRIPTION

Stern Latch				
				
Complete 802010 IP/C	Male only 802012 C	Female Only 802011 IP	Paralleling Mandrel 802014	Transfer Jig 802013

Iridium Platinum (IP) females

Melting range 3308 – 3362°F, 1820 – 1850°C

High melting temperature for soldering, or casting to with virtually all alloys.

Ceramicor (C) males

Melting range 2553 – 2715°F, 1400 – 1490°C

For soldering, welding, or casting to with gold alloys.

TOOLS LIST

802110

G/L Adjusting Tools

Three tool bars giving 6 adjustment blades increasing in thickness from 1 to 6.

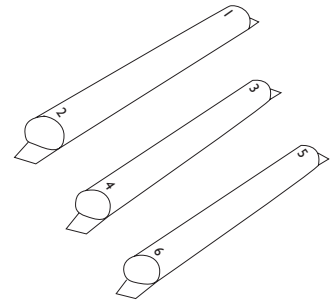

FABRICATION INSTRUCTIONS

Section I

Casting Against the Female

Section II

Soldering the Female in the Crown

Section III

Connecting the Male to the Partial Denture

A. Soldering the Male to the Partial

B. Electro-soldering the Male to the Partial

Section IV

Processing Techniques

Section V

Soldering the Male for Bridgework Applications

Section VI

Activating and Adjusting Retentions



SECTION I

CASTING AGAINST THE FEMALE

See above for attachment alloys' melting ranges.

1. The abutments should be prepared so there will be enough room for the intracoronal attachment without overcontouring the restoration (Fig. 1).
2. An accurate full arch impression should be taken. Prepare models and dies, and mount on the articulator.
3. Survey the model and establish a common path of insertion (Fig. 2).
4. Fabricate wax copings. If you are inexperienced with attachments, or if the abutment is tipped or rotated, it is best to create a full contour wax pattern.
5. Place the paralleling mandrel into the parallelometer. Slide the female onto the paralleling mandrel. If the wax pattern is full contour, cut a box into the pattern on the appropriate surface. This can easily be done by positioning the female beside the wax pattern and scribing a line into the wax with a sharp instrument. Use the female as a guide. Remove enough wax from the box shape to position the attachment as deep as necessary to maintain proper tooth contour and as low as possible (Fig. 3).
6. Incorporate the female into the coping/crown. If the abutment is to have a full-coverage porcelain crown, the attachment must have a thin layer (0.4 mm minimum) of alloy surrounding the female and supporting the portion extended above the occlusal surface of the casting. This will prevent porcelain from contacting the attachment. If this is not done, checking of the porcelain can result (Fig. 4).
7. Carefully remove the paralleling mandrel from the female. Place an instrument against the occlusal of the attachment as the mandrel is being withdrawn. This will help to keep the attachment in place.
8. As stated above, it is always a good idea to incorporate a lingual bracing arm into the partial frame design. This bracing arm reduces the tensile and compressive forces on the attachment, aids in lateral stability, and helps to guide the male portion of the attachment into the female as the patient inserts the denture. This bracing arm becomes necessary when the attachment is reduced to 4.0mm or less (Fig 5).
9. Form a groove in the wax around the female face plate with a fine explorer or Bard Parker (Fig. 6). Hold the blade at approximately a 45° angle to the female faceplate. Remove a tiny amount of wax (0.1mm) from all three sides of the faceplate, creating a bevel into which the casting investment will flow. This will help to stop alloy from casting onto the faceplate.

If you have waxed to the occlusal of the female, remove a small amount of wax from this area. This will allow the casting investment to cover the top edge of the female and prevent casting alloy from flowing inside the attachment.
10. Sprue so that the alloy will not flow directly towards the attachment. Place the pattern to provide easy access to the female when investing (Fig. 7) A direct spruing technique can be used for some single units, but an indirect technique will give you better castings.

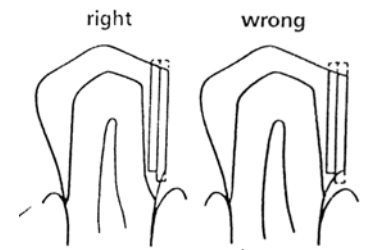

Fig. 1

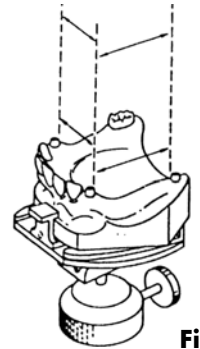

Fig. 2

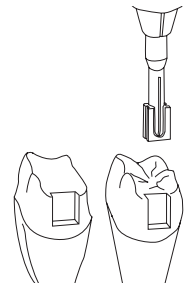

Fig. 3

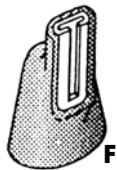

Fig. 4

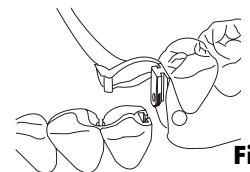

Fig. 5

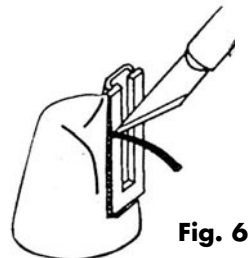

Fig. 6

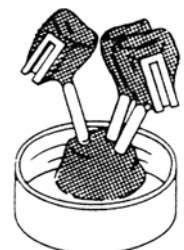

Fig. 7

11. The female and proximal plate must be absolutely clean to insure an accurate casting. A cotton swab soaked in alcohol does a good job of cleaning wax and oil residue off the metal surfaces.

Carefully fill the female with investment, using a small instrument or brush, before the casting ring is placed onto its base (Fig. 8). Debubblizers are not recommended on any part of the attachment as they may produce a film that will cause flashing.

12. Position the ring on the base and complete investment procedures, burnout, and cast. Be sure the mold is heat soaked at the proper burnout temperature for at least 1 hour. Extra time must be added for multiple rings and if you are using round rings other than the smallest size.
13. After casting, the investment can easily be slid out of the attachment using an instrument. Do not sandblast. Clean the surface of the attachment with the Sterngold Fiberglass Brush. Rubber wheels or air abrasives are not recommended as they will alter the precision surface. Try in the males for fit.

Note: Occasionally, when a mistake has been made, the attachment may fit too tightly. Sterngold Liquid Graphite is the best way to adjust the components without destroying their precision relationship. Paint the Liquid Graphite onto the male, dry it with a gentle stream of air and then work the male into and out of the female. This will ease the tight fit. This procedure can be used for all metal to metal attachments and milled parts.

Check parallelism of attachments on the cast by using the parallelometer or by connecting the males and drawing them off as if they were in the partial denture. (The Stern Latch males are shipped with the latch activated. To ease the insertion and removal of the males during fabrication the latch may be deactivated. Place a soft cloth over the latch end of the male and squeeze the latch in with a pair of pliers. Be careful not to scratch the male with the pliers. The latch may be reactivated later using the G/L Adjusting Tools.)

14. Have the finished castings tried in the mouth to check marginal fit.

Only reduce the height of the female with the male placed inside it. Cutting the female down by itself may create a bur that could be burnished down into the female when the male is inserted. This would make the attachment too tight.

15. The dentist must make an accurate passive impression (using silicone, rubber base material or plaster), incorporating the castings into the impression to create a model for the partial framework (Fig. 9).
16. Lubricate the interiors of the castings. Pour the model. If desired, prefabricate transfer dies and pour the new model. Or, seat the original dies into the crowns, seal them into the crowns with wax, and pour the model.
17. Where possible, it is best not to remove the castings from the model until after the refractory model for the partial denture has been made.
18. Porcelain or composite may be applied to the fixed restoration casting. Be careful to keep all material from inside the female.

The partial denture framework can be produced while crowns are being finished.

19. All parts, fixed and removable, should be checked individually and together before sending them to the dentist.



Fig. 8

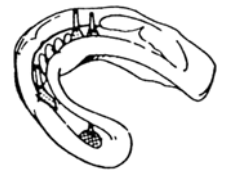

Fig. 9

SECTION II

SOLDERING THE FEMALE IN THE CROWN

1. The abutment should be prepared so there will be enough room for the intracoronal attachment without over-contouring the restoration.
2. An accurate full arch impression should be taken. Prepare models and dies and mount on the articulator.
3. Survey the model and establish a common path of insertion (Fig. 10).
4. Fabricate wax copings. If you are inexperienced with attachments, or if the abutment is tipped or rotated, it is best to create a full contour wax pattern.
5. Set the paralleling mandrel into the parallelometer. Slide the female onto the paralleling mandrel. If the wax pattern is full contour, cut a box into the pattern on the appropriate surface. This can easily be done by positioning the female beside the wax pattern and scribing a line into the wax with a sharp instrument. Use the female as a guide. Remove enough wax from the box shape to position the attachment as deep as necessary and as low as possible to fit the attachment female within the proper abutment contour.
6. If the abutment is to have a porcelain crown, the attachment must have at least a 0.4mm layer of alloy surrounding the female. This includes the portion extended above the occlusal surface of the casting. This layer will prevent porcelain from contacting the attachment surface. If porcelain touches the attachment checking may occur (Fig. 11).
7. Carefully remove the female from the wax prior to casting. A small amount of wax is removed to make room for solder.
8. Sprue, invest, burnout and cast the pattern. Rough finish and place on model.
9. Place the paralleling mandrel into the parallelometer and position the female on the mandrel. Parallel females into abutment casting(s).
10. Allow an even space around the attachment for solder. (Fig. 12)
11. Sticky wax the female into the formed recess in the abutment casting being careful not to get wax inside the attachment. (Fig. 13)
12. Carefully remove the paralleling mandrel from the female.
13. Remove the casting from the model. The casting and female are now ready for investing.
14. Using a small brush, carefully vibrate investment into the female and the crown. Place the casting horizontally into a mass of investment and cover the casting and faceplate, leaving the sticky waxed area exposed (Fig 14).
15. After the investment has set, eliminate the wax by using boiling water.
16. Choose proper solder and corresponding flux. The solder's liquidus should be at least 100°F (56°C) below the solidus of the casting alloy.

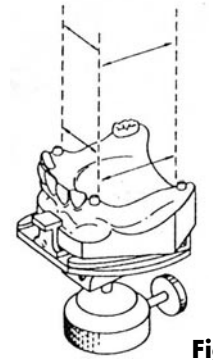

Fig. 10

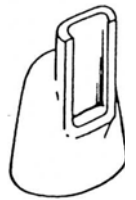

Fig. 11

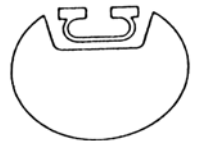

Fig. 12

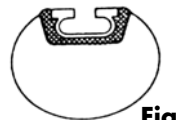

Fig. 13

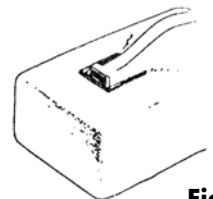

Fig. 14

17. Apply flux to the attachment and the casting. Evenly heat both components too be soldered. The two "parent" metals to be soldered should be hot enough so that when the solder touches them it melts. The torch does not melt the solder. If the metal casting and attachment are not hot enough to melt the solder remove the solder, continue heating, and then re-introduce the solder. At the correct temperature the solder will flash all the way through the joint. Position the torch flame on one side and the solder on the other. Draw the solder completely around the attachment (Fig. 15). Allow to bench cool.

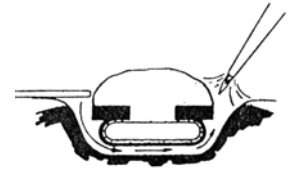

Fig. 15

18. Remove the castings/crowns from the soldering investment The investment can easily be slid out of the attachment using an instrument. Do not sandblast.

19 Clean the surfaces of the attachment with the Sterngold Fiberglass Brush (Fig. 16). Rubber wheels or air abrasives are not recommended as they will alter the precision surface. Try in the males for fit. Check parallelism of attachments on the cast by using the parallelometer. The Stern Latch males are shipped with the latch activated. To ease the insertion and removal of the males during fabrication the latch may be deactivated. Place a soft cloth over the latch end of the male and squeeze the latch in with a pair of pliers. Be careful not to scratch the male with the pliers. The latch may be reactivated later using the G/L Adjusting Tools.



Fig. 16

20. Try the castings in the mouth to check marginal fit.

21. The dentist must take an accurate passive impression (using silicone, rubber based material or plaster), incorporating the castings into the impression to create a model for the partial framework (Fig. 17).

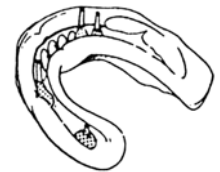

Fig. 17

22. Lubricate the interiors of the castings. If desired, fabricate transfer dies prior to pouring the new model. Or seat the original dies into the crowns, seal them into the crowns with wax, and pour the model.

23. Where possible, it is best not to remove the castings from the model until after the refractory model for the partial denture has been made.

24. Porcelain or composite may be processed to the casting. Be careful to keep all material from inside the female.

The partial denture framework can be produced while crowns are being finished.

SECTION IIIA

SOLDERING THE MALE TO THE PARTIAL

The method of soldering will determine the attachment configuration chosen. The flatbacked intracoronal attachments require a vertical strut as part of the framework design to provide a surface for connection of the attachment.

1. Carefully block out the master cast. Relieve the saddle areas. Place the attachment male in the female on the model and block out the back of the male with 32 gauge (0.3mm) sheet wax. This will provide adequate space for solder between the vertical strut and the attachment (Fig. 18).
2. Take an accurate impression (silicone is highly recommended) and pour the refractory model for the partial denture casting.

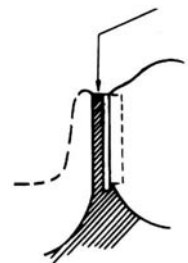

Fig. 18



- Wax the vertical strut directly against the refractory duplication of the male component. Then wax the rest of the framework (Fig. 19).

ALTERNATIVE:

Soldering chromium-cobalt frameworks will be easier if you burnish .005" platinum foil on the refractory duplication of the male. Leave a buccal and lingual extension of platinum foil to maintain its position in the casting investment. Wax the framework vertical strut to the platinum foil.

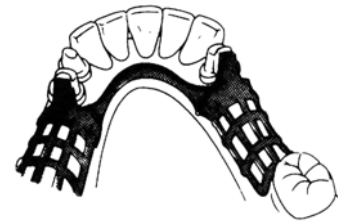

Fig. 19

- Sprue, invest, burnout and cast the framework.
- Finish the partial and cut a vertical opening into the strut with a disc to allow access to the male component (Fig. 20). If you're using the alternative technique (above), be careful not to grind off the platinum face.
- Presolder the struts on chromium-cobalt frameworks with Sterngold 2225 W (melting range 1340-1440°F, 727-782°C) solder using Sterngold Sigma-Low Flux. Presoldering is not necessary if the platinum foil technique mentioned in Step 3 was used.
- Secure the male and vertical strut in proper relationship to each other with sticky wax or autopolymerizing acrylic (Fig. 21).



Fig. 20

Some technicians do not use the platinum foil or 2225W pre-soldering techniques. If this is the case, do not use acrylic to connect the attachment male to a chromium-cobalt partial denture framework. Chromium-cobalt alloy easily forms an invisible oxide — even at relatively low heating temperatures. If you heat the acrylic to soften and remove it the oxide formed will prevent a secure bonding of the attachment male to the framework. You must grind and pick the acrylic from the joint, after investing, if this method was chosen.

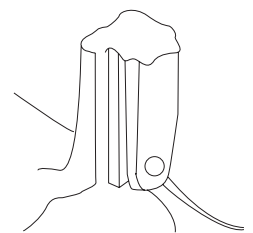

Fig. 21

- Draw the components off the model and invest them in soldering investment (Fig. 22).
- Let the investment set and remove any wax or self-cure resin.
- Apply additional Sterngold Sigma-Low Flux to help promote solder flow and limit oxidation
- Concentrate heat on the vertical strut. The temperature of both components should be just high enough to allow Sterngold Chrome 2 Solder to flow. Make sure the parent metals melt the solder, not the torch. The solder flows completely between the attachment and the vertical strut. **DO NOT OVERHEAT!**
- DO NOT QUENCH. BENCH COOL.**
- Clean the components with the Sterngold Fiberglass Brush. Rubber wheels or air abrasives are not recommended as they will alter the precision surface.
- Prepare occlusal rims and obtain an occlusal registration.
- Articulate, set teeth so as to achieve desired esthetics and occlusion.
- A try-in is recommended.

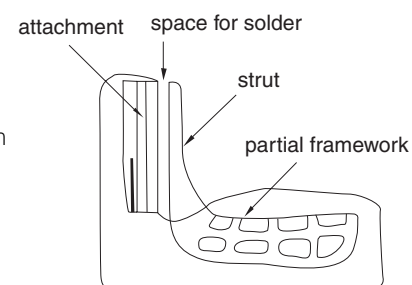

Fig. 22



SECTION III B

ELECTRO-SOLDERING THE MALE TO THE PARTIAL

1. Carefully block out the cast. Relieve the saddle areas. Assemble the attachment by inserting the male into the abutment female. Block out the back of the male with 32 gauge (0.3mm) sheet wax. This will provide adequate space for solder between the framework's vertical strut and the attachment (Fig. 23).
2. Make an impression and pour the refractory model
3. Wax a vertical strut directly against the refractory duplication of the male. The strut should extend approximately 2mm above the attachment male. Complete the wax-up for the rest of the framework as per planned design (Fig. 24).

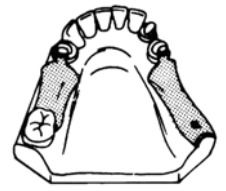

Fig. 23

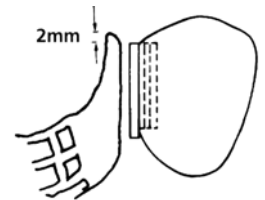

Fig. 24

ALTERNATIVE:

Soldering chromium-cobalt frameworks will be easier if you burnish .005" platinum foil on the refractory duplication of the male. Leave a buccal and lingual extension of platinum foil to maintain its position in the casting investment. Wax the framework vertical strut to the platinum foil.

4. Sprue, invest, burnout and cast the framework.
5. Finish the framework and cut a vertical opening into the strut with a disc (Fig.25).
6. Remove all wax from the cast and attachments.
7. Presolder the struts on chromium-cobalt framework with Sterngold 2225 W (melting range 1340-1440°F, 727-782°C) solder using Sterngold Sigma-Low Flux. Presoldering is not necessary if the platinum foil technique mentioned in Step 3 was used.
8. Place the framework and the assembled attachments (males inside females in the abutment crowns) on the model (Fig. 26).
9. Apply Sterngold Sigma-Low flux (a low temp. fluoride flux) to both the male and the vertical strut.
10. Tack weld (without soldering) the top of the strut to the male using an electro-soldering machine. (Fig. 27)
11. Draw the framework (with welded males attached) off the model.
12. Additional flux should be used to help promote solder flow and limit oxidation. Use Chrome 2 Solder between the male and the strut. You may protect the male with soldering investment or with a soldering heat-sink material.
13. Using a soldering torch, concentrate heat on the vertical strut. The temperature of both components should be just high enough to allow Chrome 2 Solder to flow (make sure the solder flows completely between the attachment and the vertical strut). DO NOT OVERHEAT !
14. DO NOT QUENCH. BENCH COOL.
15. Clean the components with the Sterngold Fiberglass Brush. Rubber wheels or air abrasives are not recommended as they will alter the precision surface.



Fig. 25



Fig. 26

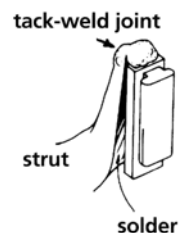

Fig. 27



16. Prepare occlusal rims and obtain an occlusal registration.
17. Articulate, set teeth so as to achieve desired esthetics and occlusion
18. A try-in is recommended.

S E C T I O N I V

PROCESSING TECHNIQUES

1. After the set-up of esthetics and occlusion is approved, place the crowns and partial back on the processing cast.
2. Using the set-up as a guide, pencil outline the desired peripheral border of the partial on the cast.
3. Using a pointed instrument, scribe along the outlined peripheral border, thus providing a transferred finishing line.
4. Remove the wax set-up and crowns.
5. Cut down the teeth and abutments on the processing cast to provide ample room for blocking out the attachments.
6. Block out the attachment males using Sterngold Rubber Sep.
7. Place only the wax set-up back on the cast. Double check the centric occlusion with the opposing-cast for correct positioning.
8. Lute and refine the wax-up at this time, making sure there is NO WAX in the males.
9. Remove the cast from the mounting plate for investing.
10. Double investing is recommended for Latch attachments.
 - a. Using a small hand instrument, invest the male attachments by vibrating "soft" plaster around the male neatly and smooth plaster over the cut down cast teeth.
 - b. After the plaster has hardened, invest the case in a conventional manner.
11. Boil out, trial pack and cure the partial.
12. Eject and deflask the partial.
13. Remount the cast into the mounting plate for occlusal adjustment.
14. Remove the processed partial from the cast and finish down to the provided finishing line.
15. If acrylic flashing seeps into the male attachments, use a pointed instrument to remove this flash.



SOLDERING THE MALE FOR BRIDGEWORK APPLICATIONS

The Stern Latch should be considered for modular fixed bridgework applications for connecting bridgework to non-parallel abutments, and when the dentist desires a non-resilient removable restoration. It may be used to permit easy conversion to a partial denture should a distal abutment later fail.

The male Stern Latch components should be soldered in place. Stern Latch males are made of Ceramicor alloy and have a melting range 2553 – 2715°F, 1400 – 1490°C Even with this high melting range we do not recommend casting against the males, unless you are using a gold alloy. With non-precious alloys there may be warping of the attachment male or formation of a brittle and corrosion prone eutectic alloy mixture where the casting and attachment male join.

1. Wax the abutment and pontics being certain to leave an adequate receptacle for soldering the male component (Fig. 28).
2. Sprue the waxed unit and draw it off the model (Fig. 29).
3. Invest, burnout and cast the Pattern.
4. Finish the casting.
5. Insert the male into the female.
6. Place both castings on the model. Sticky wax the male into the recess in the pontic, and draw off the model.
7. Invest the casting with the male component in an appropriate soldering investment ensuring that all portions of the male are covered.
8. Remove the sticky wax (boiling water).
9. Choose the proper solder (ceramic or regular) and corresponding flux.
10. Apply flux to the attachment and the casting. Evenly heat both components to be soldered. The two "parent" metals to be soldered should be hot enough so that when the solder touches them it melts. The torch does not melt the solder. If the metal casting and attachment are not hot enough to melt the solder remove the solder, continue heating, and then re-introduce the solder. At the correct temperature the solder will flash all the way through the joint instantly. Position the torch flame on one side and the solder on the other. Allow to bench cool.
11. LET BENCH COOL; THEN DIVEST.
12. Remove the investment material and clean the surfaces of the attachment with the Sterngold Fiberglass Brush. Rubber wheels or air abrasives are not recommended as they will alter the precision surface.
13. Return the casting to the model. Check the fit of all components. Check for proper fit into the female. Finish the case.

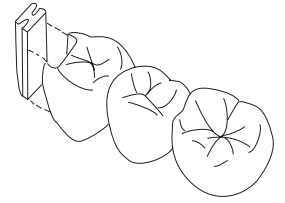

Fig. 28

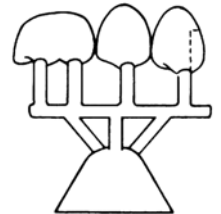

Fig. 29

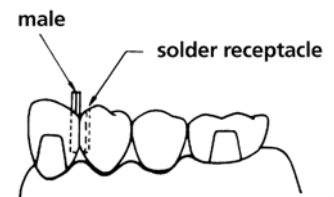

Fig. 30



Fig. 31

ACTIVATING AND ADJUSTING RETENTION

The dentist activates the attachment chairside to provide the minimum retention necessary to hold the prosthesis in place. Too much retention will cause excessive attachment wear and make the prosthesis difficult to insert and remove. The dentist should try the case in the mouth, expand the retention slot slightly, and reseat the prosthesis. If the prosthesis is still loose, repeat the procedure.

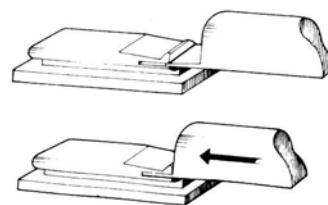

ADJUSTING THE STERN LATCH

The Stern Latch is adjusted using special precision adjustment tools. The adjustment blades are marked according to the amount of retention they will create (the higher the number the greater the retention).

1. Select an anterior attachment. Insert adjusting blade #1 into the gingival slot. Insert the tip of the blade into the side of the slot and then slide it around to the gingival.
2. Insert adjusting blade to the hilt. The back of the blade should remain flat against the back of the slot. **DO NOT PRY THE SLOT OPEN.**
3. Reseat the case in the mouth. If still loose, repeat the procedure using the adjusting blade with the next higher number.



Order online at www.sterngold.com

23 Frank Mossberg Drive • P.O. Box 2967 Attleboro, MA 02703
 Tel: (508) 226-5660 • (800) 243-9942 • Fax: (800) 531-2685

